

Arduino Gravity Analog ORP Sensor / Meter Sample Code

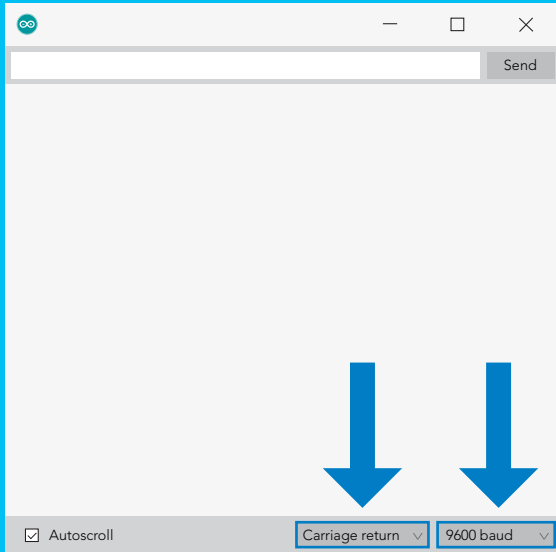

Revised 6/20



After flashing the Arduino with the code below, open the serial monitor and set it to append **carriage return** only and then set the baud rate to **9600**.

Arduino Uno

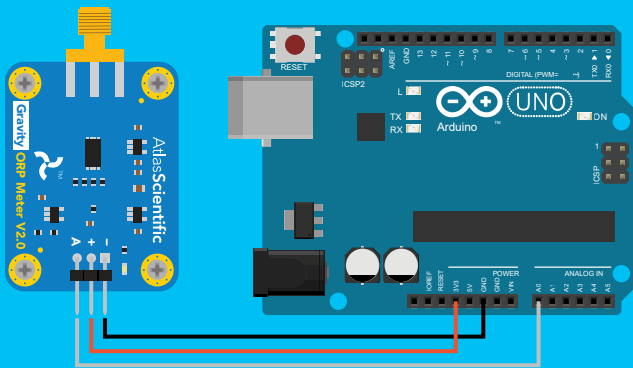

Arduino Mega

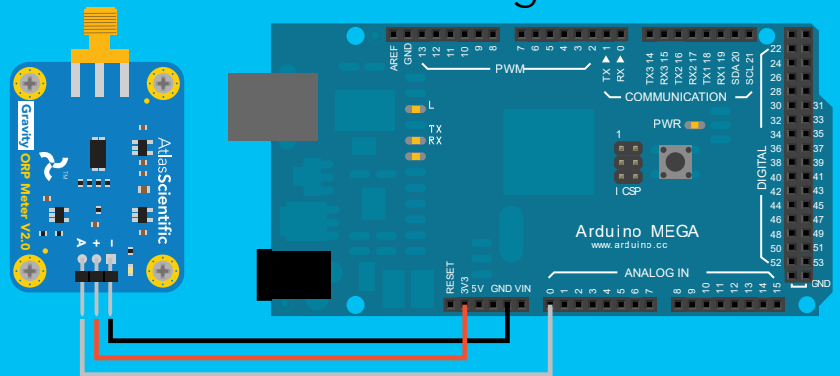

[Click here to download the sample code](#)

Then, follow the instructions on the next page.























Step 1

Download zipped library file, either from the cover page or by clicking [HERE](#).

Step 2

Move the *Atlas_gravity.zip* file to: **Documents > Arduino > Libraries**

Name	Date modified
 Atlas_gravity.zip	6/3/2019 11:02 AM
 .keep	3/15/2019 3:16 PM
 WiFi	3/8/2016 3:25 PM
 TFT	10/26/2017 10:30 PM
 Temboo	3/13/2017 12:24 AM
 Stepper	3/8/2016 3:37 PM
 SpacebrewYun	8/25/2016 4:36 PM
 Servo	11/21/2018 3:13 PM
 SD	11/22/2018 2:48 PM
 RobotIRremote	8/18/2017 11:25 AM
 Robot_Motor	8/18/2017 12:11 PM
 Robot_Control	8/18/2017 11:29 AM
 Mouse	3/8/2016 5:04 PM
 LiquidCrystal	8/10/2017 10:26 AM
 Keyboard	5/9/2018 10:02 AM
 GSM	10/2/2017 4:32 PM
 Firmata	4/15/2018 7:29 PM
 Ethernet	7/26/2018 11:37 AM
 Esplora	5/20/2015 5:10 PM
 Bridge	12/7/2017 6:39 PM
 Adafruit_Circuit_Playground	7/17/2018 6:10 PM

Step 3

Open the Arduino IDE software.

In the Arduino IDE, navigate to **Sketch > Include Library > Add .ZIP Library**.
At the top of the drop-down list, select the option to "Add .ZIP Library".

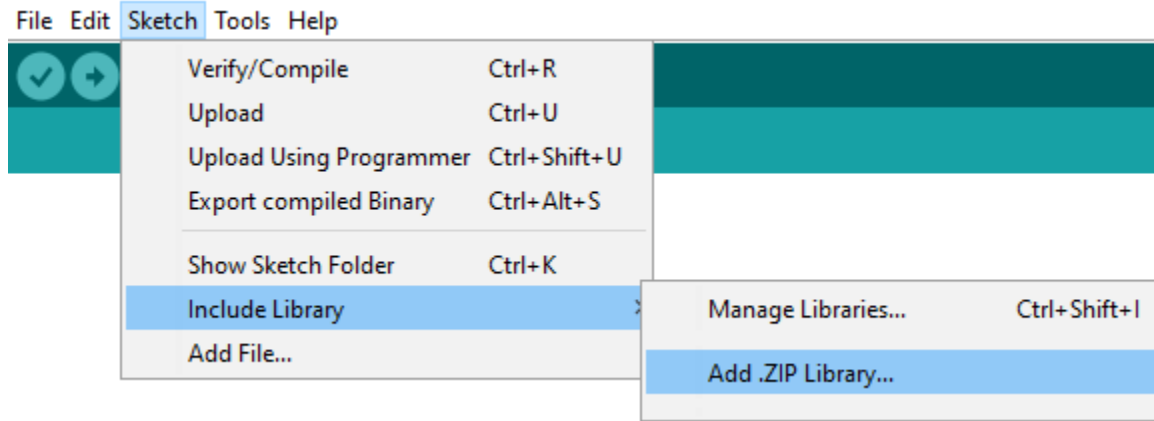

Step 4

Select "Atlas_gravity.zip" The Library file has now been installed.

**If you get an error message that says "A library named Atlas_gravity already exists", delete the old Atlas_gravity folder and zip file, then replace with the new *.zip file. and repeat step 3.

Step 5

In the Arduino IDE load the sample code.

File > Examples > Atlas_gravity > Examples > orp_grav_example

